

Trojan

**PROFESSIONAL**

**Commercial Hybrid Planks**

**INSTALLATION GUIDE**

# INSTALLATION GUIDE

## PRE INSTALLATION GUIDELINES



These installation guidelines apply to Trojan Hybrid Flooring. All instructions and recommendations should be followed for a successful installation. Hybrid floor is recommended for internal use only and should not be installed in wet areas, such as bathrooms, laundries, or external environments.

It is important to note that pre-finished Hybrid flooring should only be installed in the final stages of construction. All work involving water or moisture should be completed prior to installation. The site should be roofed and enclosed with the temperature and humidity as close as possible to in-service conditions, including the use of air conditioning. Check each board carefully prior to installation. Never install damaged planks and conduct inspections as you work.

Trojan Hybrid flooring should be acclimatized in a cool, dry location on site for 48 hours prior to installation.

The temperature of the room where the Hybrid flooring is to be laid should be between 18°C and 27°C prior and during installation. Hybrid Flooring should be protected against heat via direct sunlight - window coverings are essential to protecting the floor and form part of the warranty conditions.

Required Tools: Tape Measure, Utility Knife, Jigsaw, Tapping Block or Rubber Mallet, Pull Bar, ¼" Spacers, T-Square, Safety Glasses,

- Please inspect all planks for damage prior to installation.
- Blend and install planks from several cartons.

## 1 SUBFLOOR PREPARATION

- Trojan Hybrid Flooring can be installed over most existing hard surface floor coverings, provided that the existing floor surface is clean, flat, dry and structurally sound.
- The subfloor should be flat any unevenness must be sanded or filled with a floor leveler. Voids or humps in the sub-floor will prevent Trojan Hybrid Flooring from locking properly.
- New concrete floors need to cure for a minimum of 60 days. Prior to installing Trojan Hybrid all subfloors must be covered with a 200 UM Visqueen or similar product.
- Note Visqueen and plastic sheeting is not designed to completely seal or is a solution to rising damp. In such cases the subfloor should be sealed prior to installation of Trojan Hybrid

## 2 INSTALLATION

- Allow for a minimum 10mm expansion gap around the perimeter of the room. A gap must also be provided around pipes or at thresholds or obstacles, perimeter gaps are cover with either skirting or additional scotia. Do not fasten skirting or additional scotia direct to the floor planks. Simple press down and fasten to either the wall or existing skirting.
- For rooms over 25 ft. (7.6m) wide or over 40 ft. (12.2m) long, an additional expansion joint must be inserted. Undercut the plasterboard around the room perimeter to allow for extra expansion.
- Expansion joints are also required in doorways, and between adjoining rooms or areas where adjacent flooring is installed. Use a T-molding to cover the expansion joint.
- Trojan Hybrid Flooring is engineered to be installed utilizing the floating method.
- Do not install cabinets or fixed objects on top of the Trojan Hybrid Flooring. Proper expansion space is required. Undercut all doorjamb.

## 2 INSTALLATION CONTINUED...

- Trojan Hybrid Floor should be installed with staggered joints. Begin the first row with a whole plank, start the following rows with various sized off cuts – this will provide a more traditional look and stronger floor.
- Install the board's one plank at a time, ensuring the boards are angled correctly and the locking system is fully secured.
- Join the boards using the methods outlined below.
- Use a tapping block to tap the locking system gently on the side of the boards. use a pull bar to tap into position.
- Remember to place the planks in random positions and ensure that the end joints are staggered by at least 300mm. This ensures strength of the combined floor.
- Offcuts, of a minimum of 300mm, can be used to start the following row. This assists in achieving a random pattern.
- When installing the planks around a pipe or other obstacles, leave an expansion gap of 10mm. If there is condensation from the pipe, cut the panel so there is sufficient amount of space to keep the panel dry.

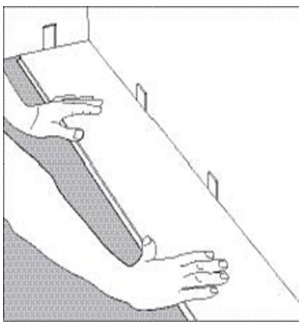

Step 1: Begin installation working from left to right. Insert spacers at ends and edges where planks meet wall. Spacers maintain expansion gap during install and are removed later

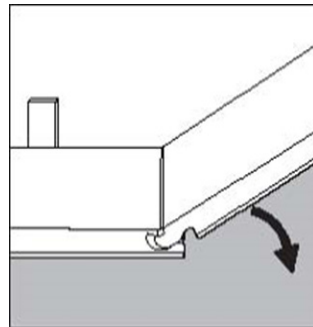

Step 2: Lock short end of plank by inserting tongue into groove at an angle and drop in place. Continue to end of first row.

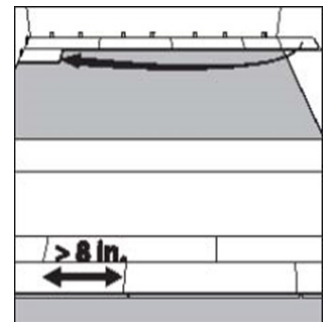

Step 3: Use leftover plank from first row as starter for second row. There must be at least 300mm between plank end joints on adjacent rows.\*

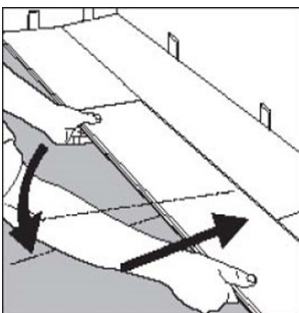

Step 4: Lock long edge of plank by inserting tongue into groove at an angle and drop in place. Slide plank toward end of previously installed plank until the tongue just touches the groove.

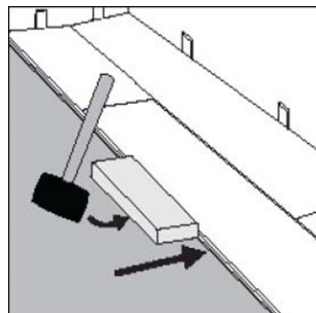

Step 5: IMPORTANT! Use hammer and tapping block to tap long edge of plank to ensure a tight fit. ANY GAPPING CAN COMPROMISE THE LOCKING SYSTEM!

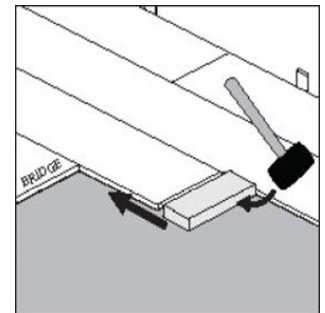

Step 6: Tap end of plank with hammer and tapping block to lock ends of planks together. Remove bridge and continue towards wall until installing the final plank in the row. BE SURE TO TAP ON EDGE SO AS NOT TO DAMAGE LOCKING PROFILE.

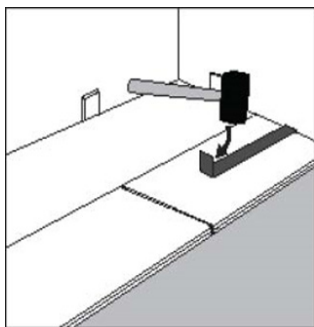

Step 7: Use hammer and pull bar to lock final piece in row. Insert spacer at end of row. Continue installation to final row.

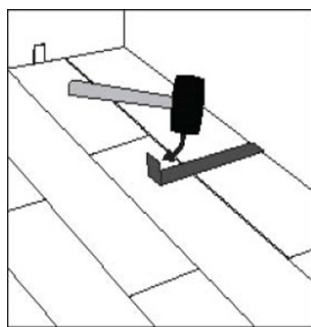

Step 8: Use hammer and pull bar to lock long edges of planks on final row.

## INSTALLING UNDER DOOR JAMBS

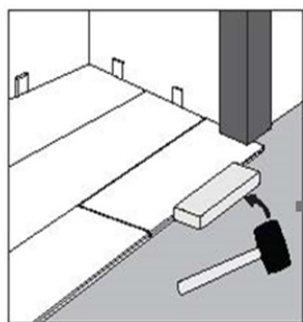

Step 1: Undercut space under door jamb to allow plank to slide freely

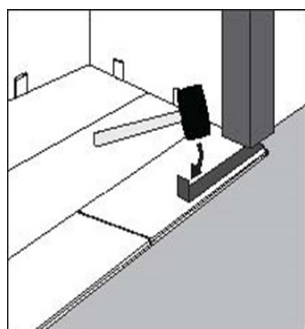

Step 2: Use hammer and pull bar to lock short end of plank.

## SKIRTING

Once floor is completely laid in a room, remove spacers and cover expansion gap with the skirting – be sure to press down the floor with the skirting before fixing.



[www.trojantimbers.com.au](http://www.trojantimbers.com.au)

4/67 Araluen Street, Kedron 4031, QLD Australia | 07 3861 4422 | [sales@trojantimbers.com.au](mailto:sales@trojantimbers.com.au)